

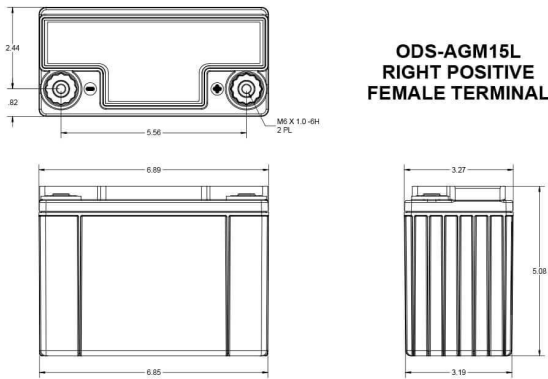

Drawings & Terminal Position



Handling and Storage

- Can be mounted or stored in any orientation except inverted
- 2-years storage life at 77°F (25°C) without needing to charge. Recharge when the OCV is <12.2V (50% SOC).
- Classified as non-spillable and approved as non-hazardous cargo for ground, sea and air transportation in accordance with the requirements of IMDG (International Maritime code for Dangerous Goods) and ICAO (International Civil Aviation Organisation)

Charging and Self-Discharge

Type of charging curve	IUU
Charger voltage at 68°F (20°C)	14.4V to 14.8V
Self-discharge per month at 68°F (20°C)	1.25%
Self-discharge per month at 104°F (40°C)	5%
80% depth of discharge cycles	400

Technical Data Sheet

ODS-AGM15L

(PC545)

Battery Type

- Group 15 Absorbed Glass Mat (AGM) battery with Thin Plate Pure Lead (TPPL)
- Up to 400 cycles at 80% depth of discharge
- Advanced dual purpose battery for engine start and deep cycle use

Power and Performance

Voltage	12V
Pulse (5 second) Hot Cranking Amps (PHCA)	460A
Cold Cranking Amps (CCA)	150A
HCA	280A
MCA	220A
20Hr Nominal Capacity (Ah)	13Ah
10Hr Nominal Capacity (Ah)	12Ah
Reserve Capacity Minutes	18 mins
Terminal	M6 Receptacle
Torque Spec in-lbs (Nm max)	50 (5.6)
Internal Resistance (mΩ)	10 mΩ
Short Circuit (A)	1200A

Dimensions and Weight

Length	6.9 in / 175 mm
Width	3.3 in / 84 mm
Height (terminals included)	4.9 in / 124 mm
Height (container)	5.1 in / 130 mm
Weight	11.4 lbs / 5.2 kg

Temperature

Operating temperature range	-40°F / -40°C to 113°F / +45°C
Optimum storage temperature	68°F / +20°C

Accreditations

The management systems governing the manufacture of this product are ISO 9001 and ISO 14001 certified.

*Cold Start Performance S.A.E J537 Apr 2016



EnerSys World Headquarters
2366 Bernville Road
Reading, PA 19605, USA
Tel: +1-800-964-2837

EnerSys EMEA
EH Europe GmbH
Baarerstrasse 18
6300 Zug, Switzerland

EnerSys Asia
152 Beach Road
#11-08 Gateway East
Building
Singapore 189721
Tel: +65 6416 4800

Want more info?
Scan code to access
the ODYSSEY® Battery
Literature Library

